

The DULPEDIA 2024

SMALL SUNDRIES

Desktop 334

Fashion Glasses 352

Glasses Accessory 354

DULTON Goods 356





Stackable drawer

材質：スチール



Horizontal
 Model 121-376
 H.73 W.320 D.240mm
 ¥5,400+税



Galvanized
 Model 121-376GV
 4 997337 080392



Ivory
 Model 121-376IV
 4 997337 080385

Vertical
 Model 121-377
 H.73 W.240 D.320mm
 ¥5,400+税



Galvanized
 Model 121-377GV
 4 997337 080415



◎最大3個までスタッキング可能。
 ◎背面には固定用のフックがあります。



Ivory
 Model 121-377IV
 4 997337 080408

Partition storage

材質：亜鉛鉄板



◎仕切りのワイヤーは取り外し可能。

S / Galvanized
Model D20-0210S/GV
H.320 W.200 D.250mm
¥3,600+税
4 997337 068727



M / Galvanized
Model D20-0210M/GV
H.320 W.300 D.250mm
¥4,300+税
4 997337 068741

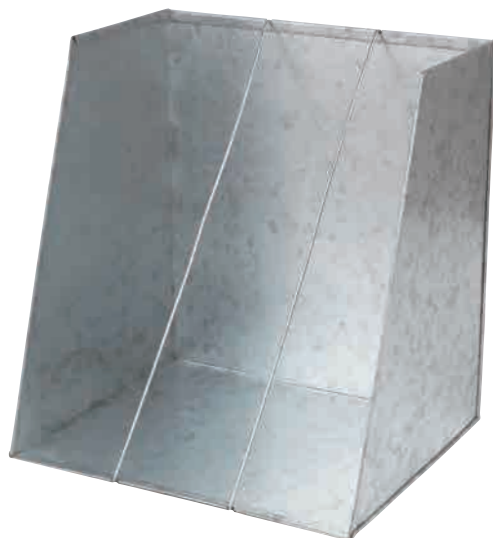

File box

材質：亜鉛鉄板



S / Galvanized
Model D20-0209S/GV
H.250 W.100 D.320mm
¥3,500+税
4 997337 068680



M / Galvanized
Model D20-0209M/GV
H.250 W.150 D.320mm
¥3,800+税
4 997337 068703

Metal clip board

材質：ボード/アルミニウム
クリップ/真鍮(Brass)、スチール(Galvanized)



A6
Model 117-330A6
120×190mm

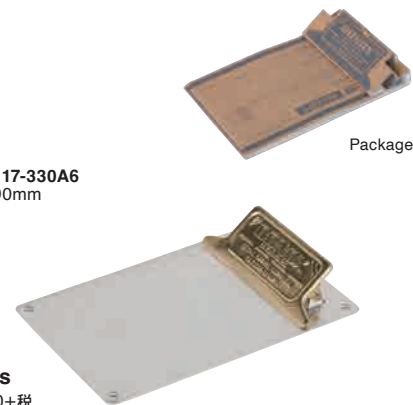

Brass
¥1,400+税
4 997337 733014

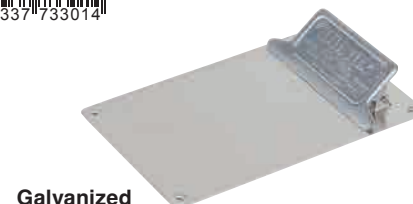

Galvanized
¥1,200+税
4 997337 733021

B5
Model 117-330B5
190×290mm



Brass
¥2,200+税
4 997337 733038



Galvanized
¥2,000+税
4 997337 733045

A4
Model 117-330A4
220×340mm

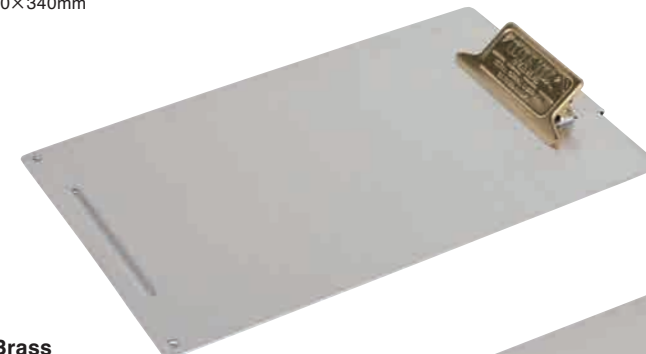

Brass
¥2,500+税
4 997337 733052



Galvanized
¥2,300+税
4 997337 733069



Brass



Galvanized



HOUSEWARE

GARDEN & GREEN

KITCHENWARE

SMALL SUNDRIES



Metal clip Model 117-329
46×117×33mm

材質：Brass (真鍮)
Galvanized, Color (スチール)



Color	Price	Barcode
● Brass	¥900+税	4 997337 732918
● Galvanized		4 997337 732925
● Ivory		4 997337 732932
● Red	¥500+税	4 997337 732949
● Yellow		4 997337 732956
● Olive drab		4 997337 732963



Package



6 colored clips



Red Yellow Olive drab

A
Model 118-345A
L.50mm / pc

Color	Price	Barcode
● Red		4 997337 845335
● Yellow	¥680+税	4 997337 845342
● Olive drab		4 997337 845373



◎1色6pcsセット



Galvanized Ivory Red
Yellow Olive drab

B
Model 118-345B
L.55mm / pc

Color	Price	Barcode
● Galvanized	¥380+税	4 997337 845410
● Ivory		4 997337 845427
● Red	¥680+税	4 997337 845434
● Yellow		4 997337 845441
● Olive drab		4 997337 845472



◎1色6pcsセット

Magnetic hook set of 2



Chrome Ivory Red Yellow Blue Dark green Black

Model B520-329
H.32 φ15mm
¥700+税



Color	Barcode
● Chrome	4 997337 032902
● Ivory	4 997337 032919
● Red	4 997337 032926
● Yellow	4 997337 032933

Color	Barcode
● Blue	4 997337 032957
● Dark green	4 997337 032964
● Black	4 997337 032995



◎1色2pcsセット



Magnet key storage

Model 121-375
H.68 W.105 D.30mm
Keyring 4 pcs
¥1,800+税
材質：スチール、アルミニウム、マグネット



Back



Galvanized
Model 121-375GV
4 997337 077569



Ivory
Model 121-375IV
4 997337 077583

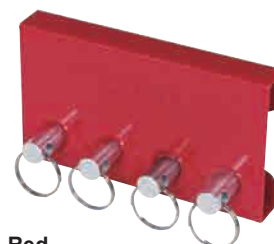

Red
Model 121-375RD
4 997337 077576

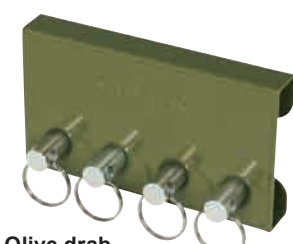

Olive drab
Model 121-375OV
4 997337 077590

◎壁に打ったビスなどに引っ掛けてご使用ください。
付属の両面テープで、ビスを打たずに設置も可能です。

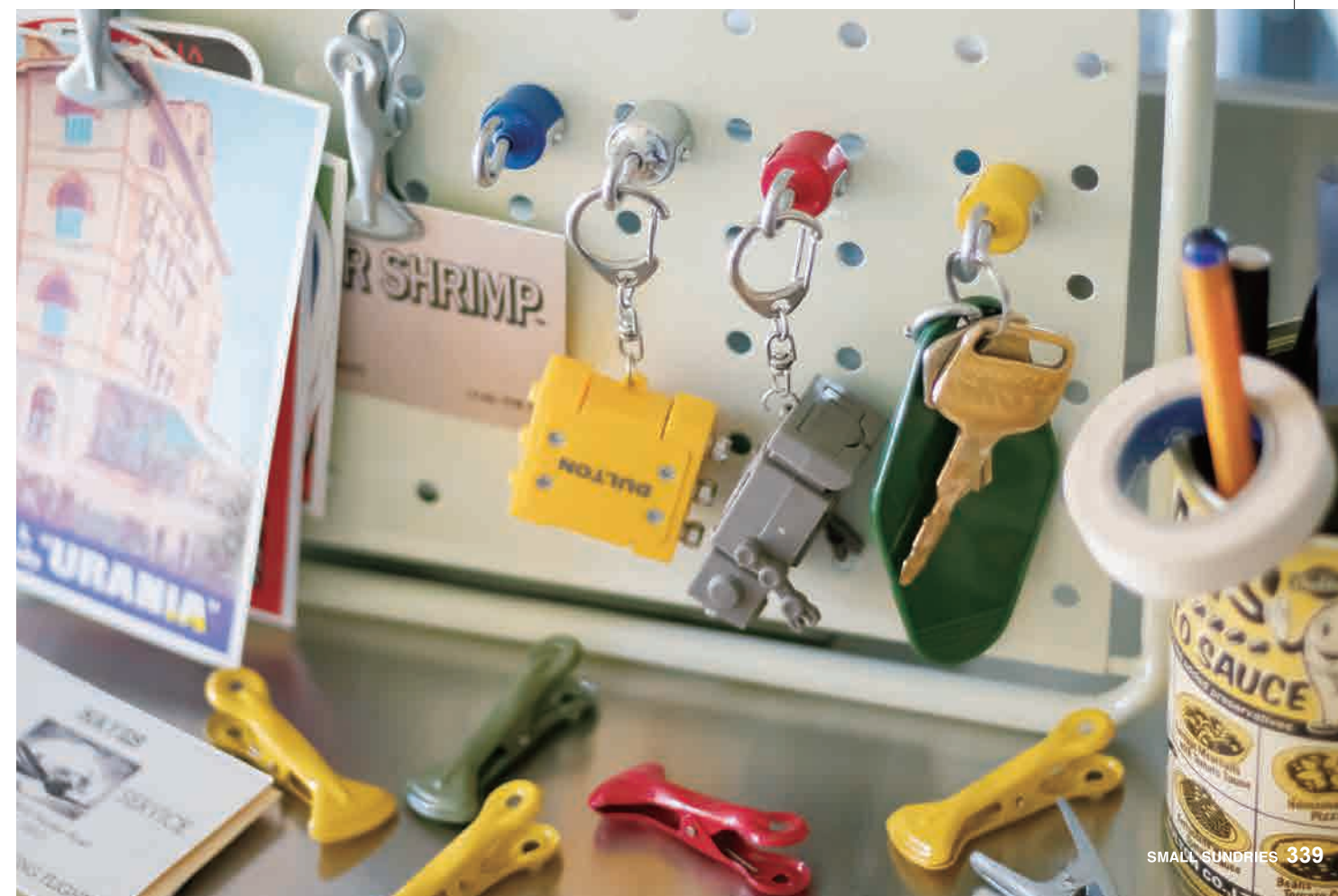



Mini pegboard
 Model 120-363
 Pegboard H.300 W.200 D.10mm×2pcs
 材質：スチール、ステンレス
 付属品 ジョイント×2set

Color

- Raw ¥3,000+税 4 997337 069113
- Ivory 4 997337 069120
- Red 4 997337 069137
- Yellow ¥2,700+税 4 997337 069144
- Olive drab 4 997337 069175
- Navy 4 997337 069168
- H.gray 4 997337 069182



Raw



Ivory

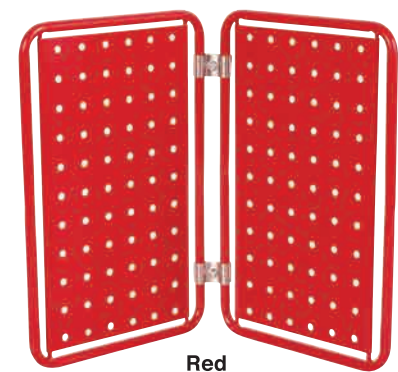

Red

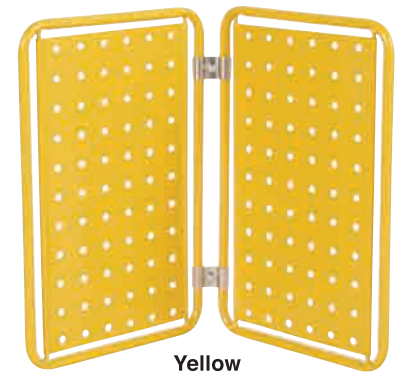

Yellow

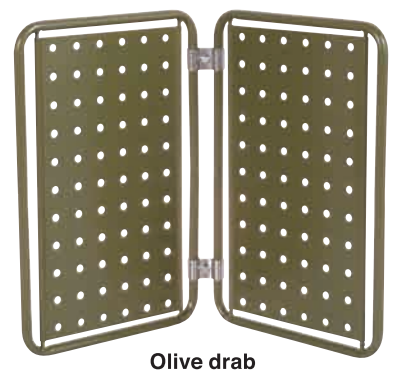

Olive drab

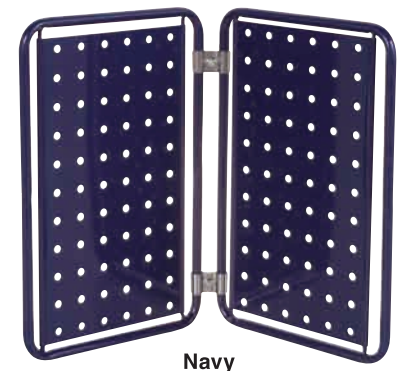

Navy

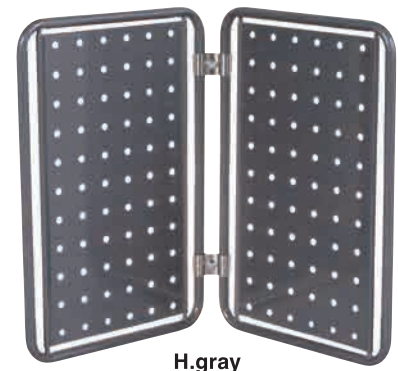

H.gray

Mini pegboard joint set
 Model 120-363J
 Pegboard H.300 W.200 D.10mm×1pc
 材質：スチール、ステンレス
 付属品 ジョイント×2set

Color

- Raw ¥1,800+税 4 997337 069199
- Red ¥1,500+税 4 997337 069229

◎Model 120-363の追加連結パーツセット

◎P341掲載のModel D19-0043にも連結可能です。



Mini fence
 Model D19-0043
 Fence H.305 W.200 D.9mm×2pcs
 付属品 ジョイント×2set
 ¥4,300+税 4 997337 058995



Mini fence joint set
 Model D19-0043J
 Fence H.305 W.200 D.9mm×1pc
 付属品 ジョイント×2set
 ¥2,800+税 4 997337 059008

◎P340掲載のModel 120-363にも連結可能です。



Desktop tray
 材質：スチール、アルミニウム
 205×95×22mm
 Inside 180×70×20mm
 ¥800+税
 LOT 3pcs



◎コーナーに1箇所、製造工程上必要な穴が空いています。あらかじめご了承ください。



Ivory
 Model 120-365IV
 4 997337 074971



Red
 Model 120-365RD
 4 997337 074988



Yellow
 Model 120-365YL
 4 997337 074995



Olive
 Model 120-365OV
 4 997337 075008



Navy
 Model 120-365NB
 4 997337 075015

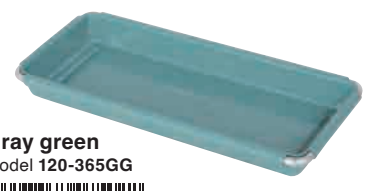

Gray green
 Model 120-365GG
 4 997337 075022

Document box

Model 120-353
265×75×358mm
Inside 250×65×340mm
¥3,500+税
材質：スチール、ステンレススチール

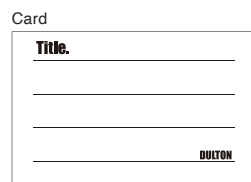
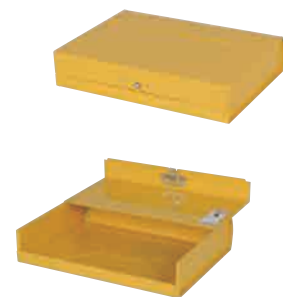

Yellow

- Color
- Raw 4 997337 074728
 - Ivory 4 997337 074735
 - Red 4 997337 074742
 - Yellow 4 997337 074773
 - Navy 4 997337 074766

◎付属の取り扱い説明書内のカードを切り取るとタイトルカードとしてご利用いただけます。



Magnetic memo bar long
Model Y926-1234
W.365mm
¥1,300+税
4 997337 912341



Magnetic memo bar
Model S026-20
W.185mm
¥1,000+税
4 997337 026208



Magnetic clip set of 5



Type-A
Model CH14-H495A
L.50mm/ pc
¥680+税
4 997337 144957



Type-B
Model CH14-H495B
L.55mm/ pc
¥680+税
4 997337 449526



Memo clip
Model CH02-M22S
H.40mm
¥400+税
4 997337 029223



Bolt and nut magnet set of 2
Model Y926-1235
H.28 W.17 D.20mm
¥1,000+税
4 997337 912358



4 Magnetic clips



Model TZ3160
50×20mm / each
¥1,100+税
4 997337 631600



Desktop basket

Model H20-0187
H.52 W.150 D.95mm
¥500+税
材質：ABS樹脂、スチール
LOT 6pcs



Red

- Color
- Ivory 4 997337 067683
 - Red 4 997337 067645
 - Yellow 4 997337 067652
 - Navy 4 997337 067669
 - Green 4 997337 067676
 - Gray 4 997337 067690
 - Sax 4 997337 067706
 - Orange 4 997337 067737
 - Mint green 4 997337 067713
 - Pink 4 997337 067720

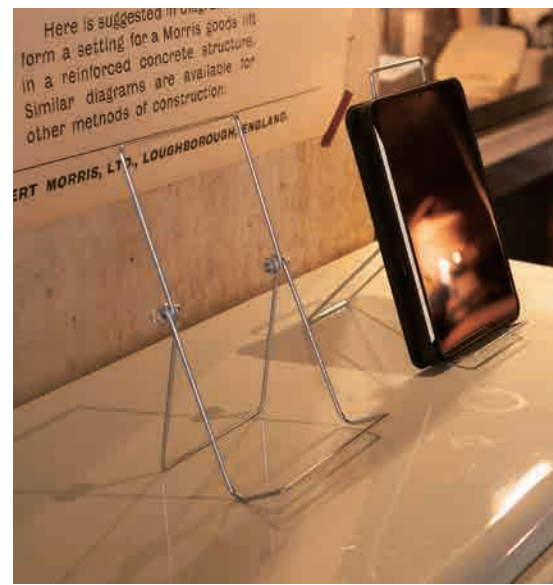

Desktop wire stand

材質：スチール



M
Model RN-0442ZCM
H.230 W.110 D.35mm
¥550+税
4 997337 083126



L
Model RN-0442ZCL
H.225 W.158 D.37mm
¥600+税
4 997337 083140



Title clip



S
Model DC10-H49S
17×60×21mm
Card 15×52mm
¥140+税
◎タグは付属しません。
4 997337 310499



L
Model DC10-H49L
24×75×26mm
Card 21×67mm
¥160+税
◎タグは付属しません。
4 997337 410496

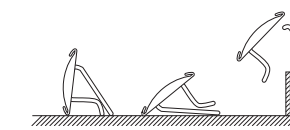

◎様々な設置方法が可能です。(クリップ式、スタンド式)



Padded envelope bag

材質：HDPE、ポリエステル
 ◎完全防水ではありません。



Tablet

Inside



Yellow

Gray

White



13 inch laptop



15 inch laptop

Yellow

	Model	Size	Price	
Tablet	Y925-1247TB	H.230 W.165mm	¥1,400+税	4 997337 924719
13 inch laptop	Y925-1247LT13	H.340 W.260mm	¥1,900+税	4 997337 924726
15 inch laptop	Y925-1247LT15	H.382 W.285mm	¥2,000+税	4 997337 924733

Gray

	Model	Size	Price	
Tablet	Y925-1247TBGY	H.230 W.165mm	¥1,400+税	4 997337 087698
13 inch laptop	Y925-1247MGY	H.340 W.260mm	¥1,900+税	4 997337 087704
15 inch laptop	Y925-1247LGY	H.382 W.285mm	¥2,000+税	4 997337 087711

White

	Model	Size	Price	
Tablet	Y925-1247TBWT	H.230 W.165mm	¥1,400+税	4 997337 087728
13 inch laptop	Y925-1247MWT	H.340 W.260mm	¥1,900+税	4 997337 087735
15 inch laptop	Y925-1247LWT	H.382 W.285mm	¥2,000+税	4 997337 087742



Wax canvas tool pouch

材質：コットン100% (ワックス加工)、真鍮



S

H.155 W.250mm
 ¥1,000+税



Olive
 Model T21-0338S/OV
 4 997337 077033



Camel
 Model T21-0338S/CAM
 4 997337 077026

L

H.235 W.340mm
 ¥1,400+税



Olive
 Model T21-0338L/OV
 4 997337 077057



Camel
 Model T21-0338L/CAM
 4 997337 077040



Tool kit



Car service
Model K755-875
H.175 W.310 D.70mm
¥3,400+税

4 997337 758758

◎単3電池×4pcs使用。
◎電池は付属しません。



Package

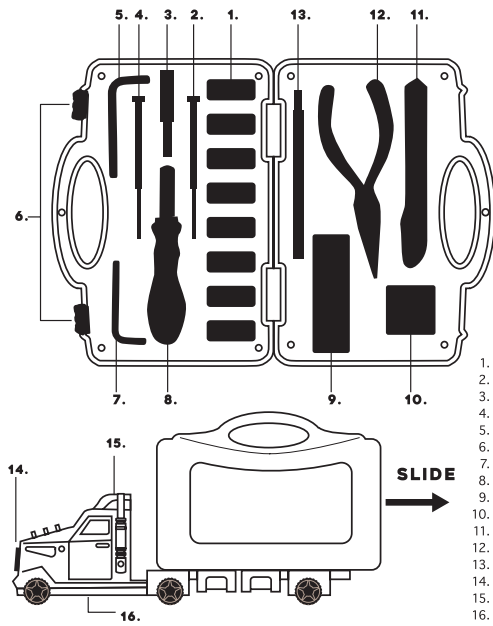

1. SOCKETS
2. SCREWDRIVER
3. SOCKET EXTENSION
4. SCREWDRIVER
5. HEX WRENCH
6. SLIDE LOCK
7. HEX WRENCH
8. HANDLE
9. DRIVER BIT & SOCKET ADAPTERS
10. MEASURING TAPE
11. UTILITY KNIFE
12. PRYERS
13. MAGNETIC PICKUP BAR
14. LED FLASH LIGHT
15. ON/OFF SWITCH FOR LIGHT
16. BATTERY BOX FOR LIGHT

SLIDE



Motor oil
Model R755-877
H.230 W.150 D.60mm
¥3,000+税

4 997337 758772

◎単4電池×4pcs使用。
◎電池は付属しません。



Package

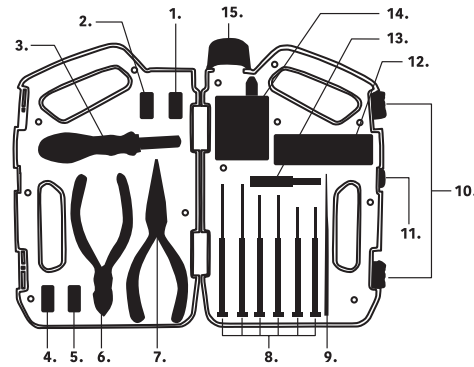

1. 10mm SOCKET
2. 9mm SOCKET
3. HANDLE
4. 8mm SOCKET
5. 7mm SOCKET
6. NIPPERS
7. PRYERS
8. SCREWDRIVERS
9. TWEEZERS
10. SLIDE LOCK
11. ON/OFF SWITCH FOR LED LIGHT
12. DRIVER BIT & SOCKET ADAPTERS
13. SOCKET EXTENSION BAR
14. BATTERY BOX FOR LIGHT
15. LED FLASH LIGHT



Military
Model K755-876OV
H.85 W.160 D.65mm
¥1,400+税

4 997337 787628

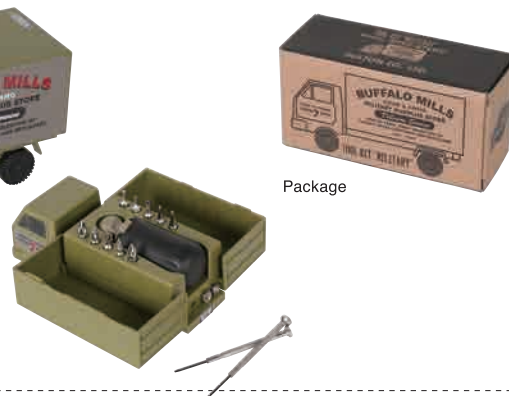

Package

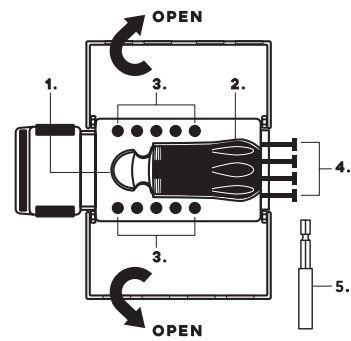

1. BIT HOLDER
2. GRIP
3. BIT SET, 10PCS
4. SCREWDRIVERS, 4PCS
5. EXTENTION HOLDER



Delivery
Model K755-876NB
H.85 W.160 D.65mm
¥1,400+税

4 997337 787611

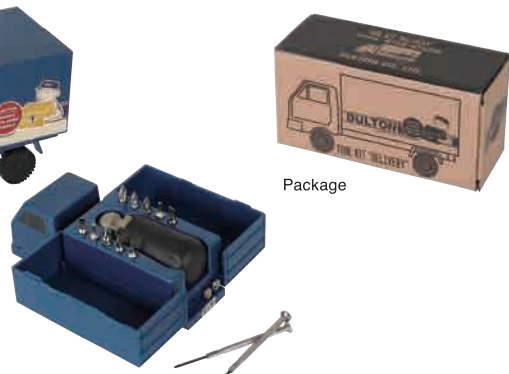

Package

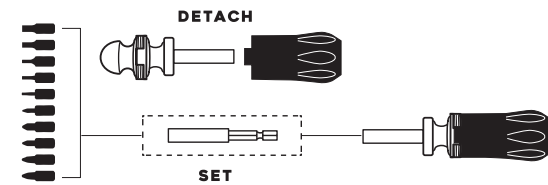

GENERAL CAUTION
NOT A TOY
KEEP AWAY FROM CHILDREN
◎玩具ではありません。

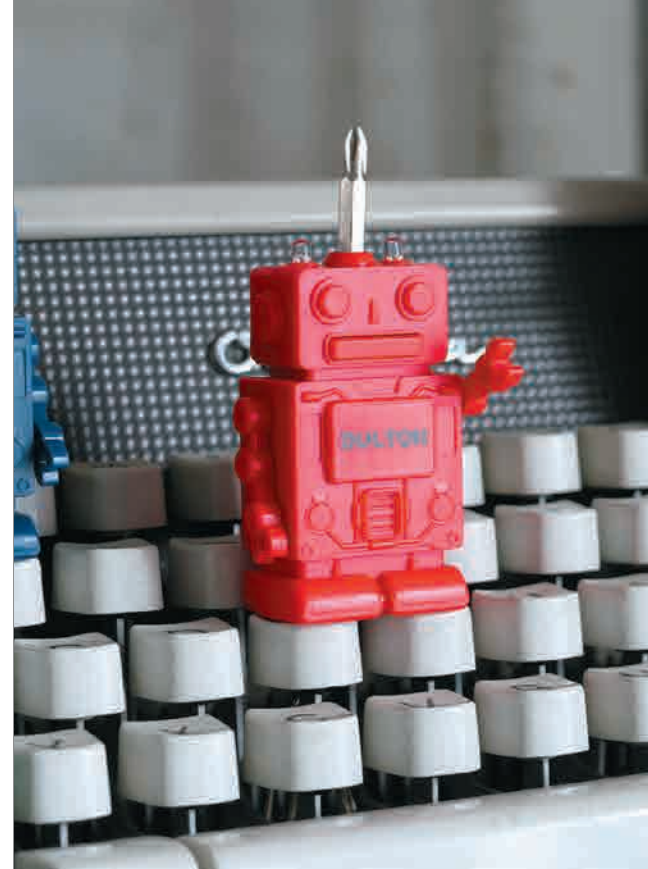

Tool key chain "Robot"

H.54 W.36 D.20mm
Chain L.52mm
¥680+税
LOT 6pcs

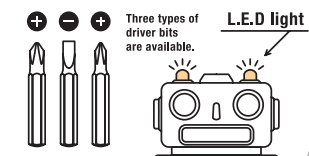

◎ボタン電池 CR2032 × 1pc 使用。



Package



Gray
Model K825-1064GY

4 997337 816410



Red
Model K825-1064RD

4 997337 816427



Navy
Model K825-1064NB

4 997337 816434

Section box

H.65 W.260 D.155mm
Inside H.40 W.75 D.145mm / each
¥750+税
材質：ポリプロピレン
LOT 3pcs



◎パーテーション取り外し可能



Dark green / Blue
Model H20-0127GN/BL

4 997337 063920

Gray / Yellow
Model H20-0127GY/YL

4 997337 063937

Light gray / Red

Model H20-0127GY/RD
4 997337 063913



Green / White

Model H20-0127GN/WT
4 997337 063944



Purple / Black

Model H20-0127PL/BK
4 997337 063951



Stash safe spray can

H.175 φ70mm
 ¥500+税
 材質：テンプレート、ポリプロピレン
 LOT 3pcs



De-icer
 Model H20-0176DI
 4 997337 067133



Fly ded
 Model H20-0176FD
 4 997337 067140



Machine oil
 Model H20-0176MO
 4 997337 067157



Blow jet
 Model H20-0176BJ
 4 997337 067164



Medi-quick
 Model H20-0176MQ
 4 997337 067171



Stash safe canned

H.110 φ75mm
 ¥600+税
 材質：テンプレート、ポリプロピレン
 LOT 3pcs



Beans
 Model H20-0177BN
 4 997337 067195



Lobster bisque
 Model H20-0177LB
 4 997337 067188



Pickles
 Model H20-0177PL
 4 997337 067201



Art ashtray

H.25 W.103 D.130mm
 ¥700+税
 材質：ポーセリン



Type-E
 Model G555-539ES
 4 997337 539111

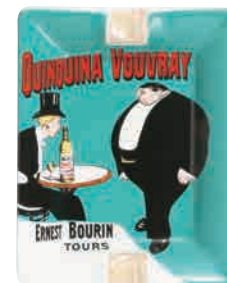

Type-K
 Model G555-539KS
 4 997337 539180



Type-L
 Model G555-539LS
 4 997337 086004



Type-M
 Model G555-539MS
 4 997337 086011



Type-N
 Model G555-539NS
 4 997337 086028



Type-P
 Model G555-539PS
 4 997337 086035



Type-Q
 Model G555-539QS
 4 997337 086042



Type-R
 Model G555-539RS
 4 997337 086059



Type-S
 Model G555-539SS
 4 997337 086066



Type-T
 Model G555-539TS
 4 997337 086073



Printed packing tape
 Model PPT
 5cm×50m
 ¥350+税
 材質：OPP
 LOT 6pcs



PPT-1
 1 color
 4 997337 018708



PPT-3
 1 color
 4 997337 018722



PPT-5
 1 color
 4 997337 018746



PPT-6
 2 colors
 4 997337 018753



PPT-7
 2 colors
 4 997337 018760



PPT-12
 2 colors
 4 997337 018807



PPT-21
 2 colors
 4 997337 066471



PPT-22
 2 colors
 4 997337 066486



PPT-23
 2 colors
 4 997337 066495

Glass block bank 
 材質：ガラス、ポリプロピレン



Square
 Model H20-0192SQ
 H.145 W.145 D.80mm
 ¥1,800+税



SIDE



投入口：40×3mm
 キャップを外した
 口径：φ45mm

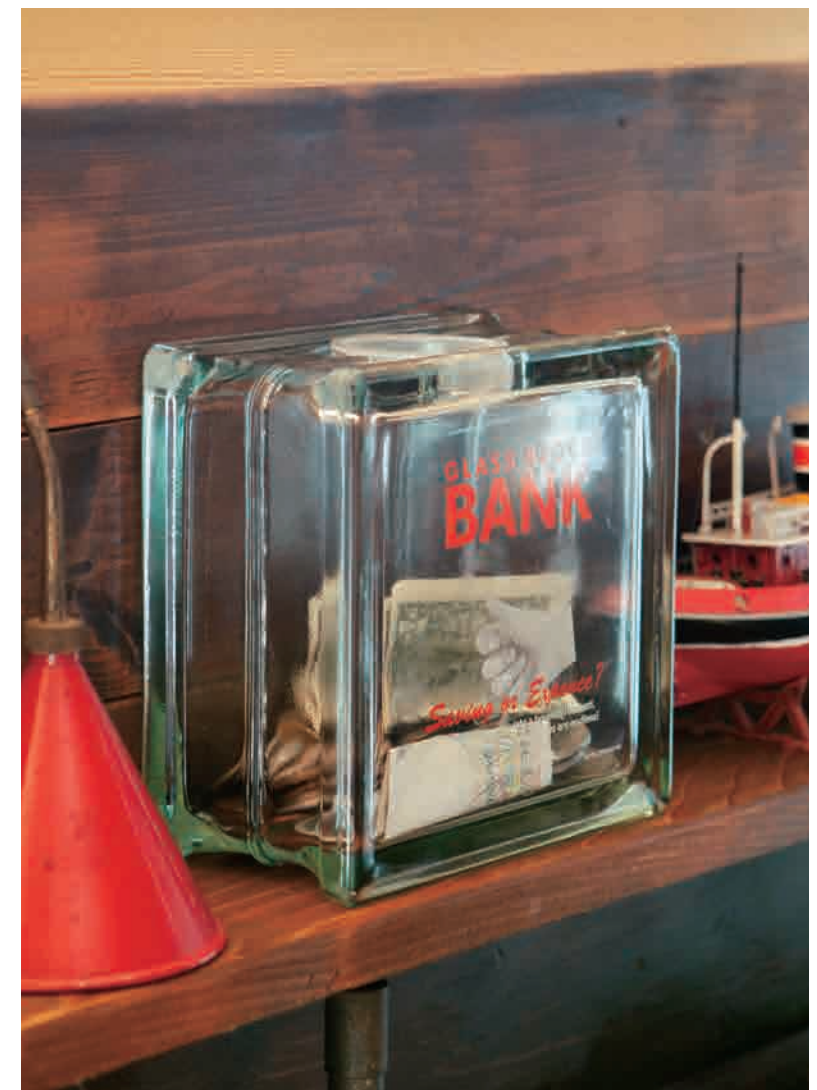

Package



Glass sound expander 
 Model A555-532
 H.260 W.133 D.135mm
 ¥6,200+税

◎製造工程上、若干の歪みやスジ、大きさや重量に多少の個体差が生じる場合があります。あらかじめご了承ください。

Bonox calculator 
 Model Y825-1056
 H.38 W.113 D.176mm
 ¥2,400+税



Package



FASHION GLASSES



Model YGJ132LGY/BL

Model YGJ132LGY/BR

Model YGJ115 UV

¥2,800+税
フレーム：アセテート

紫外線透過率 1% 可視光線透過率
Blue lens 59%
Green lens 67%
Brown lens 59%



Black / Blue lens
Model YGJ115BK/BL
4 997337 089784



Black / Green lens
Model YGJ115BK/GN
4 997337 089777



Black / Brown lens
Model YGJ115BK/BR
4 997337 065238



Tortoise / Blue lens
Model YGJ115TO/BL
4 997337 065245



Tortoise / Green lens
Model YGJ115TO/GN
4 997337 089791



Tortoise / Brown lens
Model YGJ115TO/BR
4 997337 089807



Light gray / Blue lens
Model YGJ115LGY/BL
4 997337 089814



Light gray / Green lens
Model YGJ115LGY/GN
4 997337 065252



Light gray / Brown lens
Model YGJ115LGY/BR
4 997337 089821

Model YGJ132 UV

¥2,800+税
フレーム：アセテート

紫外線透過率 1% 可視光線透過率
Blue lens 59%
Green lens 67%
Brown lens 59%



Black / Blue lens
Model YGJ132BK/BL
4 997337 089838



Black / Green lens
Model YGJ132BK/GN
4 997337 089845



Black / Brown lens
Model YGJ132BK/BR
4 997337 065085



Tortoise / Blue lens
Model YGJ132TO/BL
4 997337 065092



Tortoise / Green lens
Model YGJ132TO/GN
4 997337 089869



Tortoise / Brown lens
Model YGJ132TO/BR
4 997337 089852



Light gray / Blue lens
Model YGJ132LGY/BL
4 997337 089876



Light gray / Green lens
Model YGJ132LGY/GN
4 997337 065108



Light gray / Brown lens
Model YGJ132LGY/BR
4 997337 089883

NEW ARRIVAL

CAR & OUTDOOR

FURNITURE

HOUSEWARE

GARDEN & GREEN

KITCHENWARE

SMALL SUNDRIES

GLASSES ACCESSORY



Folding case

Model CH13-S485
H.35 W.160 D.63mm
¥750+税



Light brown
4 997337 348553



Dark gray
4 997337 348591



Dark brown
4 997337 348560



Package

Denim glasses case

Model A325-118
H.43 W.163 D.60mm
¥800+税



Dark blue
4 997337 511858



Light blue
4 997337 511841



◎厚手生地のため、ご使用直後は生地が馴染んでおらず、折りたたみにくい場合があります。
数回「折りグセ」をつけることで生地が馴染んでいきます。
◎眼鏡の形状・サイズによっては収納できない場合があります。◎眼鏡は付属しません。

Glasses case "Mustang"

Model A625-787
H.70 W.175 D.35mm
¥800+税



Black
4 997337 578721



Red
4 997337 578738



Brown
4 997337 578745



Natural
4 997337 578752

Glasses case "Caravan"

Model A925-1251
H.75 W.170 D.40mm
¥900+税



Beige
材質：PULレザー、アイアン
4 997337 925518



Black
材質：PULレザー、アイアン
4 997337 925525



Brown
材質：PULレザー、アイアン
4 997337 925532



Navy
材質：PULレザー、アイアン
4 997337 925549



Red
材質：PULレザー、アイアン
4 997337 925556



Denim
材質：コットン、PULレザー、アイアン
4 997337 925563

◎眼鏡の形状・サイズによってはご使用できない場合があります。◎眼鏡は付属しません。

DULTON T-shirt oval logo



¥3,600+税
材質：コットン100%

S 着丈 63 / 身幅 51 / 肩幅 44cm
M 着丈 65 / 身幅 53 / 肩幅 46cm
L 着丈 67 / 身幅 55 / 肩幅 48cm
XL 着丈 69 / 身幅 57 / 肩幅 50cm



Front print

White

Black

Navy

Yellow

Color	Size S	Size M	Size L	Size XL
○ White	T22-0474S/WT 4 997337 084079	T22-0474M/WT 4 997337 084086	T22-0474L/WT 4 997337 084093	T22-0474XL/WT 4 997337 084109
● Navy	T22-0475S/NB 4 997337 084116	T22-0475M/NB 4 997337 084130	T22-0475L/NB 4 997337 084147	T22-0475XL/NB 4 997337 084161
● Black	T22-0476S/BK 4 997337 084178	T22-0476M/BK 4 997337 084185	T22-0476L/BK 4 997337 084192	T22-0476XL/BK 4 997337 084208
● Yellow	T22-0477S/YL 4 997337 084215	T22-0477M/YL 4 997337 084222	T22-0477L/YL 4 997337 084239	T22-0477XL/YL 4 997337 084246

DULTON Long T-shirt oval logo



¥4,500+税
材質：コットン100%

S 着丈 64 / 身幅 52 / 肩幅 43cm
M 着丈 66 / 身幅 54 / 肩幅 45cm
L 着丈 68 / 身幅 56 / 肩幅 47cm
XL 着丈 70 / 身幅 58 / 肩幅 49cm



Front print

White

Gray

Color	Size S	Size M	Size L	Size XL
○ White	T22-0459S/WT 4 997337 083690	T22-0459M/WT 4 997337 083706	T22-0459L/WT 4 997337 083775	T22-0459XL/WT 4 997337 083775
● Gray	T22-0459S/GY 4 997337 083560	T22-0459M/GY 4 997337 083577	T22-0459L/GY 4 997337 083584	T22-0459XL/GY 4 997337 083607



Mini wheel barrow
Model CH06-H271
H.60 W.130 D.60mm
¥880+税



Mini tool cart
Model CH07-H304
H.35 W.100 D.60mm
¥880+税



DULTON Wappen

Model 118-336
¥850+税



A) Company
93×96mm



B) Metal products
73×80mm



C) Delivery service
100×64mm



D) Botany
68×90mm



E) Hardware
75×73mm



DULTON Can case

Model 118-343
H.125 φ65mm
¥1,400+税



A
4 997337 834315



B
4 997337 834322



C
4 997337 834339



Package